

THE INFORMATION CONTAINED HEREON IS PROPRIETARY AND CONFIDENTIAL TO DYNACOM CORPORATION. AND SHALL NOT BE USED OR DISCLOSED, IN WHOLE OR IN PART WITHOUT FIRST OBTAINING THE WRITTEN PERMISSION OF DYNACOM CORPORATION.

ZONE	REV	DESCRIPTION	DATE	APPV.
-	A	INITIAL RELEASE	06/07/07	E.A.

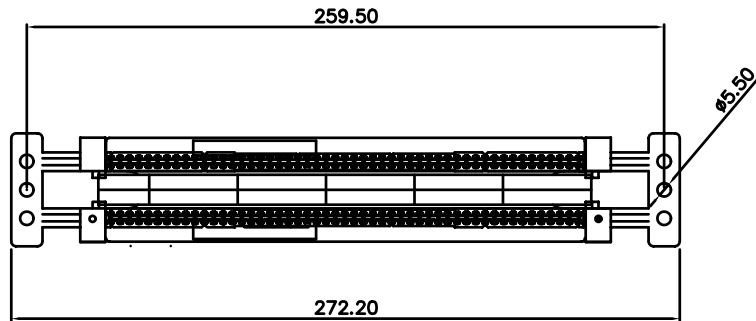

ITEM	PARTS DESCRIPTION	QTY	P/N
1	50 PR BASE WITH LEG	1	110-50FT
2	25 PR INSERT	2	-
3	INDEX HOLDER	1	110PH

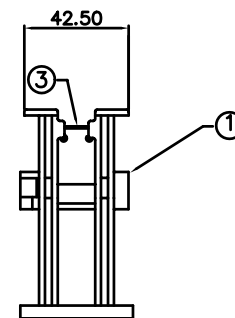
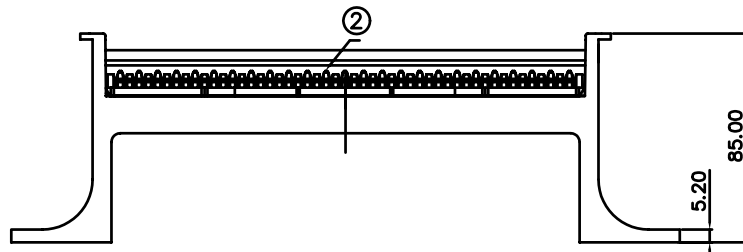

e-mail.....info@dynacomcorp.com
 1366 San Mateo Ave Suite 201
 South San Francisco CA 94080

NEXT ASSY: -	DRAWN: E.A. 06/07/07	CHECKED: J.T.	
TITLE: 50-Pair w/Legs (w/o Cable Entries)		DWG. NO. 110AWB-50	REV. A

1 2

THE INFORMATION CONTAINED HEREON IS PROPRIETARY AND CONFIDENTIAL TO DYNACOM CORPORATION. AND SHALL NOT BE USED OR DISCLOSED, IN WHOLE OR IN PART WITHOUT FIRST OBTAINING THE WRITTEN PERMISSION OF DYNACOM CORPORATION.

ZONE	REV	DESCRIPTION	DATE	APPV.
-	A	INITIAL RELEASE	03/28/06	E.A.
C4	B	110-100FT was 110-50FT.	02/24/15	E.A.
C4	C	ADDED ITEM 4, ITEM 2 WAS 4. ADDED 110PS. ITEM 1 WAS 110-50FT	02/25/15	E.A.

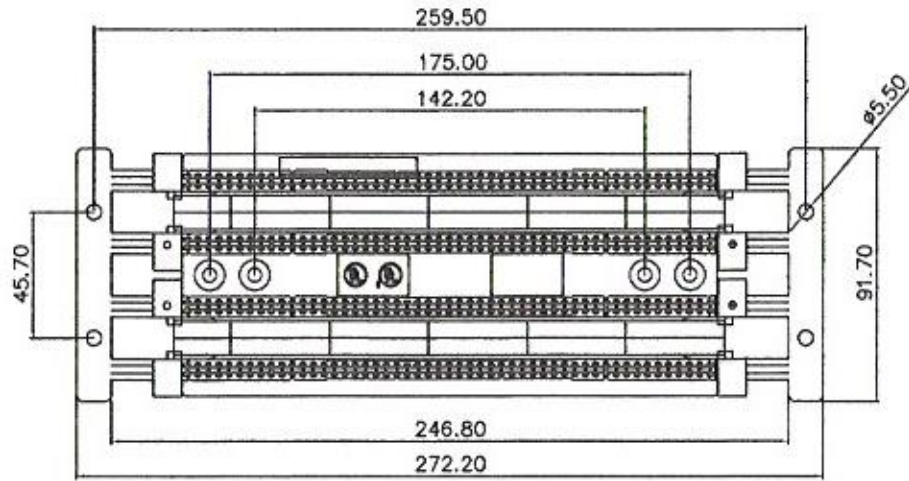

NOTES:

1. MATERIAL: P.C.
2. PART TO BE FREE OF BURRS, SUCKS & SCRATCHES.
3. DRAFT ANGLE: 1° MAX.
4. ALL UNSPECIFIED CORNER, EDGE, OR FILLET BREAKS ARE TO BE 0.50mm MAXIMUM.

ITEM	DESCRIPTION	QTY	P/N
1	100 PR BASE WITH LEGS	1	110AWB-100
2	DESI STRIP-WHITE	2	110PS
3	INDEX HOLDER	2	110PH
4	C4 & C5 CLIPS	20 C4 & 4 C5	110C-4/5

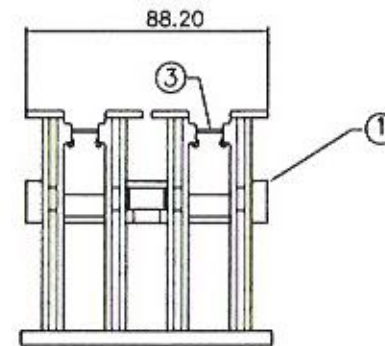
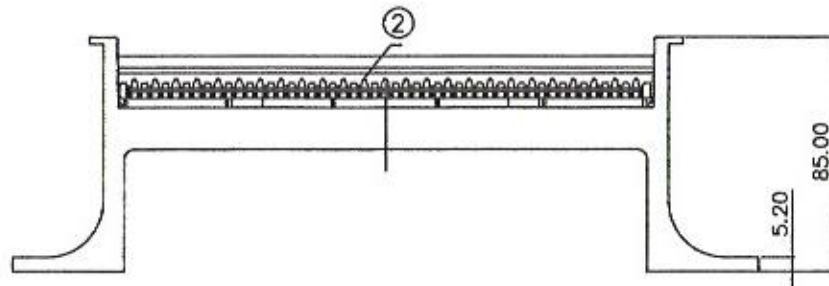

e-mail.....sales@dynacomcorp.com
www.dynacomcorp.com

ALL DIMENSIONS SHOWN ARE IN MM

NEXT ASSY: -	DRAWN: E.A. 03/28/06	CHECKED: J.T.	
TITLE: 100-Pair w/Legs, w/Clips		DWG. NO. 110B-B100FT	REV. C

THE INFORMATION CONTAINED HEREON IS PROPRIETARY AND CONFIDENTIAL TO DYNACOM CORPORATION. AND SHALL NOT BE USED OR DISCLOSED, IN WHOLE OR IN PART WITHOUT FIRST OBTAINING THE WRITTEN PERMISSION OF DYNACOM CORPORATION.

ZONE	REV.	DESCRIPTION	DATE	APPV.
-	A	INITIAL RELEASE	06/07/07	E.A.

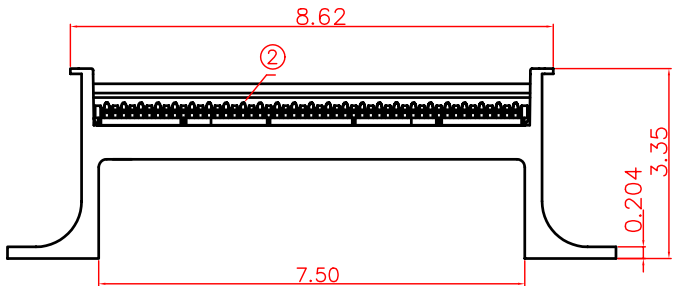
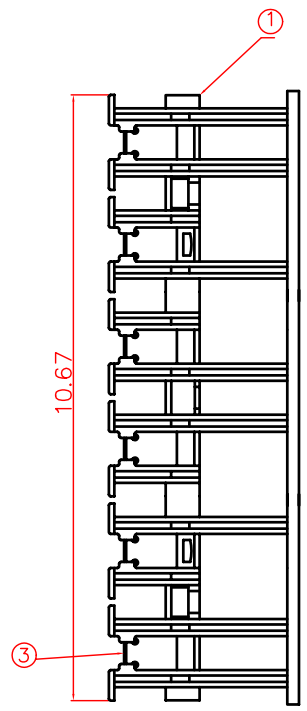
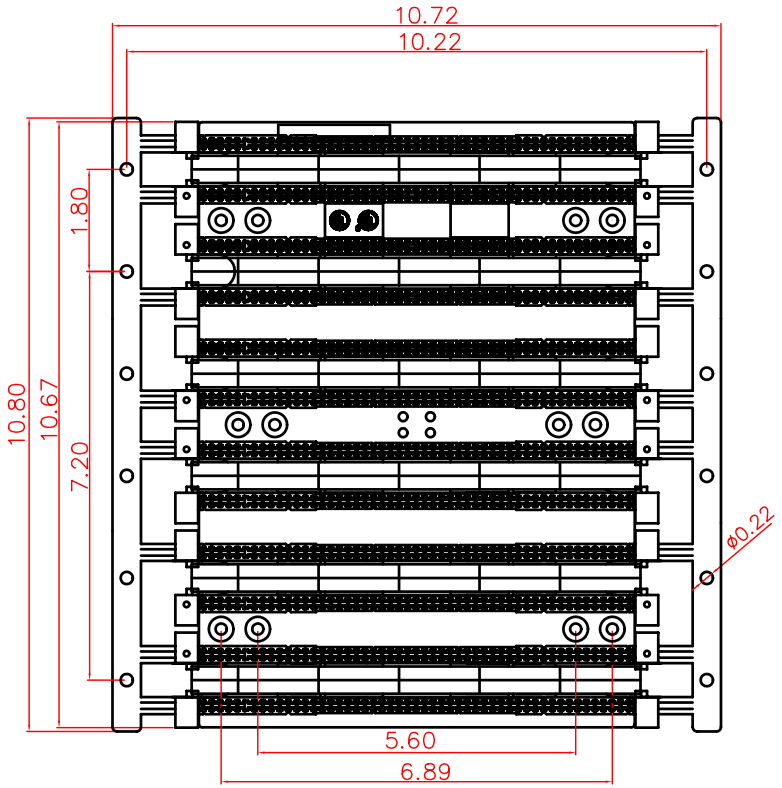

ITEM	PARTS DESCRIPTION	QTY	P/N
1	300 PR BASE WITH LEG	1	110-300FT
2	25 PR INSERT	12	-
3	INDEX HOLDER	6	110PH



e-mail.....info@dynacomcorp.com
 1366 San Mateo Ave Suite 201
 South San Francisco CA 94080

NEXT ASSY: -	DRAWN: E.A. 06/06/2007	CHECKED: J.T.
TITLE: 300-Pair w/Legs (w/o Cable Entries)	DWG. NO. 110AWB-300	REV. A

THE INFORMATION CONTAINED HEREON IS PROPRIETARY AND CONFIDENTIAL TO DYNACOM CORPORATION. AND SHALL NOT BE USED OR DISCLOSED, IN WHOLE OR IN PART WITHOUT FIRST OBTAINING THE WRITTEN PERMISSION OF DYNACOM CORPORATION.

ZONE	REV	DESCRIPTION	DATE	APPV.
-	A	INITIAL RELEASE	12/05/00	E.A.

NOTES:

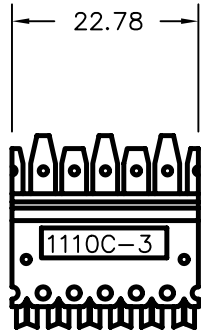

3 PAIR

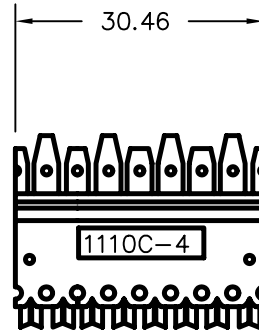
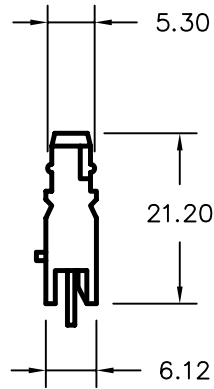

4 PAIR

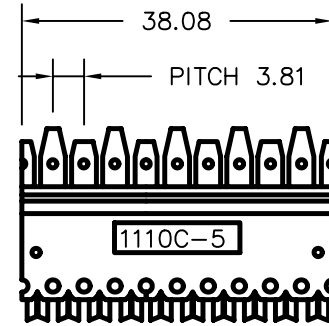
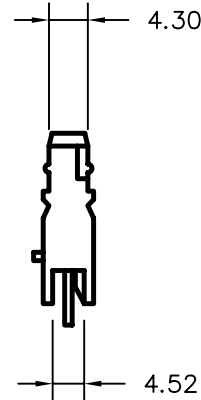

5 PAIR

ITEM	QTY	DESCRIPTION
1	1	6P TERMINAL HOUSING
2	6	1.D.C. TERMINAL
3	1	6P TERMINAL INSERT

ITEM	QTY	DESCRIPTION
1	1	8P TERMINAL HOUSING
2	8	1.D.C. TERMINAL
3	1	8P TERMINAL INSERT

ITEM	QTY	DESCRIPTION
1	1	10P TERMINAL HOUSING
2	10	1.D.C. TERMINAL
3	1	10P TERMINAL INSERT



e-mail.....joet@dynacomcorp.com

1366 San Mateo Ave Suite 201
South San Francisco CA 94080

TOLS. .X=+/- 0.030, .XX=+/- 0.010, .XXX=+/- .005, ANGLES=+/-0.5 DEG.

NEXT ASSY: -	DRAWN: E.A. 12/05/00	CHECKED: Joe Tornello
TITLE: I.D.C. Connecting Blocks	DWG. NO. 110C-3/4/5	SHEET 1 OF 1 REV. A