

THE INFORMATION CONTAINED HEREON IS PROPRIETARY AND CONFIDENTIAL TO DYNACOM CORPORATION AND SHALL NOT BE USED OR DISCLOSED, IN WHOLE OR IN PART WITHOUT FIRST OBTAINING THE WRITTEN PERMISSION OF DYNACOM CORPORATION.
 SPECIFICATIONS ARE SUBJECT TO CHANGE WITHOUT NOTICE.

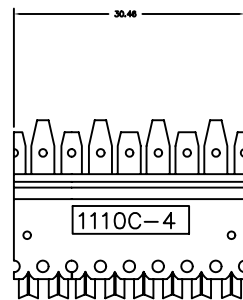

4 PAIR

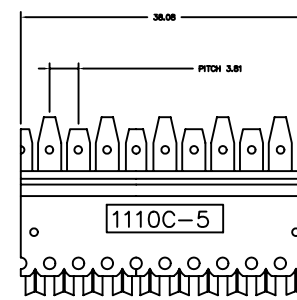

5 PAIR

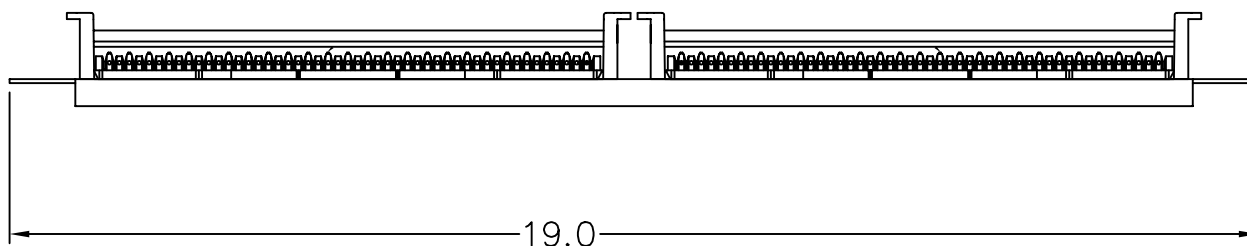
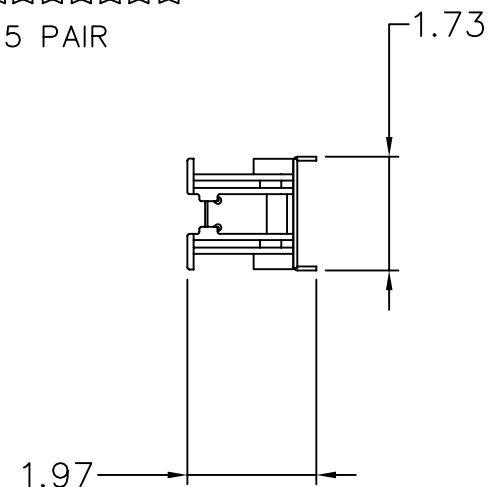
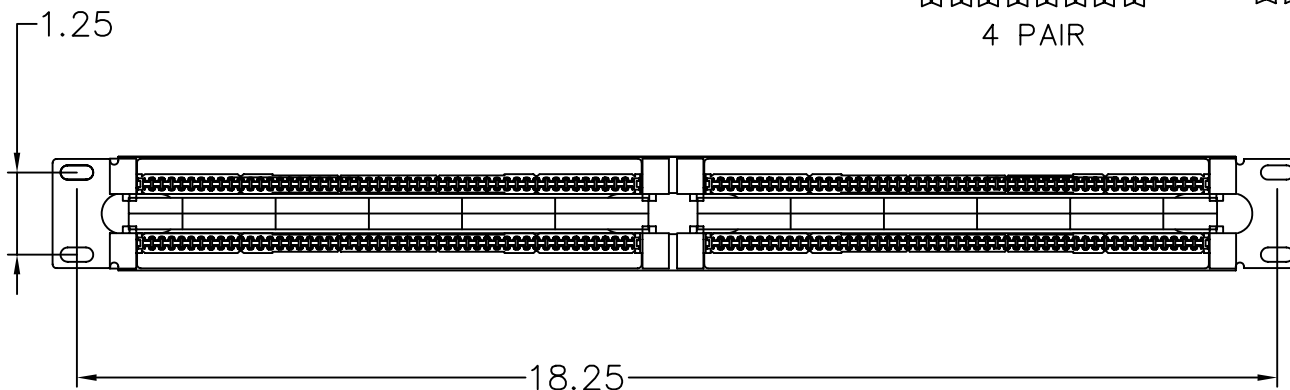

All Dimensions Are In Inches (in)
 X=CONNECTOR TYPE
 A=5-PAIR
 B=4-PAIR



e-mail.....info@dynacomcorp.com

1366 San Mateo Ave Suite 201
 South San Francisco CA 94080

TITLE:
 19" RACK MOUNT 100 PAIR

DWG. NO.
 110RM-100-X

REV.

THE INFORMATION CONTAINED HEREON IS PROPRIETARY AND CONFIDENTIAL TO DYNACOM CORPORATION AND SHALL NOT BE USED OR DISCLOSED, IN WHOLE OR IN PART WITHOUT FIRST OBTAINING THE WRITTEN PERMISSION OF DYNACOM CORPORATION. SPECIFICATIONS ARE SUBJECT TO CHANGE WITHOUT NOTICE.

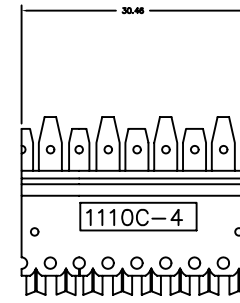

4 PAIR

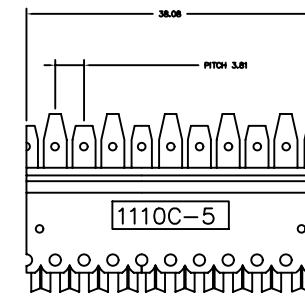

5 PAIR

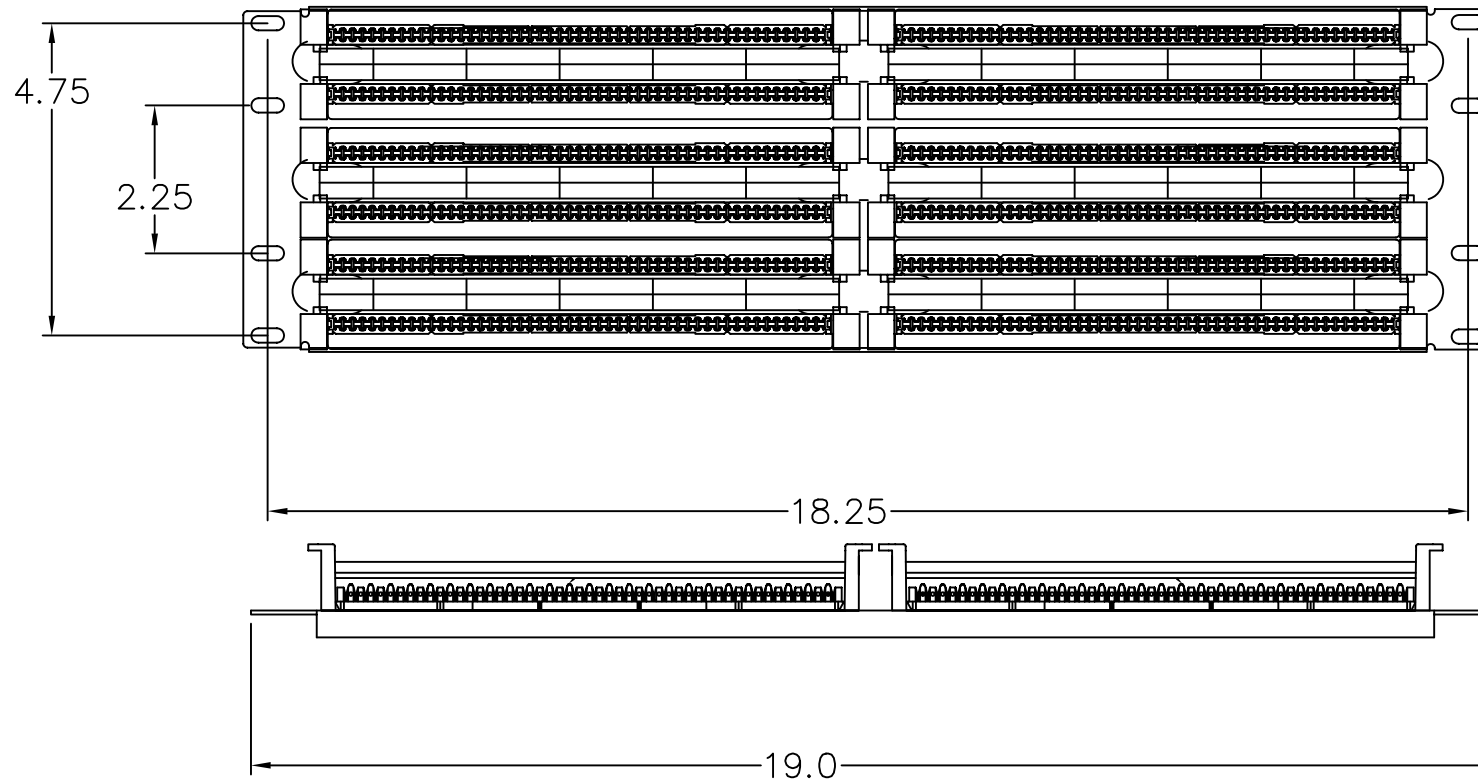

All Dimensions Are In Inches (in)
 X=CONNECTOR TYPE
 A=5-PAIR
 B=4-PAIR



e-mail.....info@dynacomcorp.com

1366 San Mateo Ave Suite 201
 South San Francisco CA 94080

TITLE:
 19" RACK MOUNT 300 PAIR

DWG. NO.
 110RM-300-X

REV.