

THE INFORMATION CONTAINED HEREON IS PROPRIETARY AND CONFIDENTIAL TO DYNACOM CORPORATION. AND SHALL NOT BE USED OR DISCLOSED, IN WHOLE OR IN PART WITHOUT FIRST OBTAINING THE WRITTEN PERMISSION OF DYNACOM CORPORATION. SPECIFICATIONS SUBJECT TO CHANGE WITHOUT NOTICE.

ZONE	REV.	DESCRIPTION	DATE	APPV.
-	A	INITIAL RELEASE	11/18/2015	E.A.

Notes:

Colors: 110625-4-IV Ivory

110625-4-WH White

Wiring Diagram shown are for 6P6C

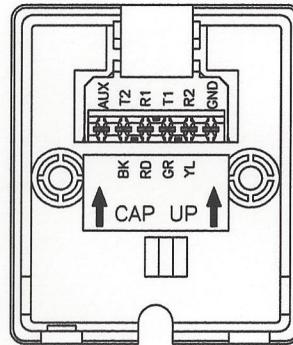
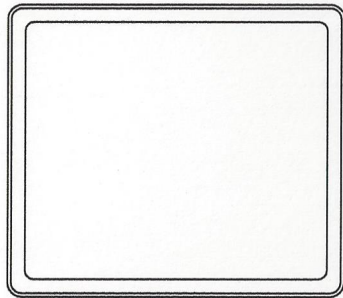

BASE

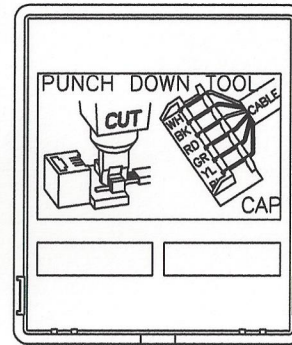

COVER

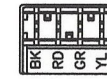

CAP (4P)

ITEM	DESCRIPTION
1	TERMINAL 4P
2	TERMINAL HOLDER 4P
3	BASE
4	COVER
5	CAP 4P

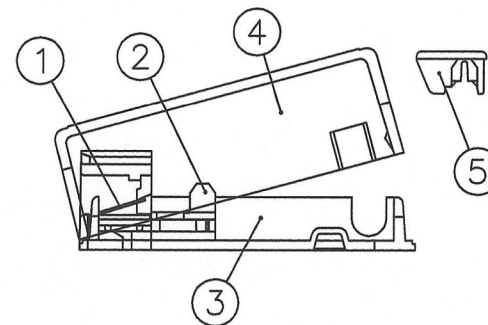
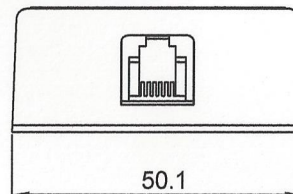
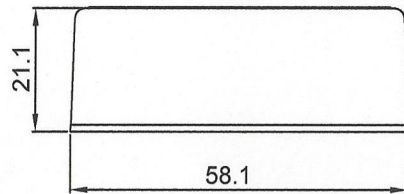

e-mail....sales@dynacomcorp.com  
www.dynacomcorp.com

TOLS ~ 20MM ± 0.2MM, OVER 20MM TO 60MM ± 0.4MM, OVER 60MM ± 0.8MM. ANGLES ± 1 DEG

NEXT ASSY:- DRAWN: E.A. 11/18/2015 CHECKED: EA

TITLE Surface Jack, 6P4C Punchdown Termination DWG. NO. 110625-4-XX SHEET 1 OF 1 REV. A

THE INFORMATION CONTAINED HEREON IS PROPRIETARY AND CONFIDENTIAL TO DYNACOM CORPORATION. AND SHALL NOT BE USED OR DISCLOSED, IN WHOLE OR IN PART WITHOUT FIRST OBTAINING THE WRITTEN PERMISSION OF DYNACOM CORPORATION. SPECIFICATIONS SUBJECT TO CHANGE WITHOUT NOTICE.

ZONE	REV.	DESCRIPTION	DATE	APPV.
-	A	INITIAL RELEASE	11/18/2015	E.A.

Notes:

Colors: 110625-6-IV Ivory  
 110625-6-WH White

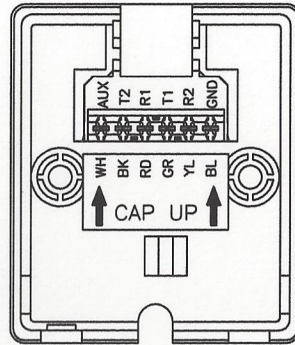
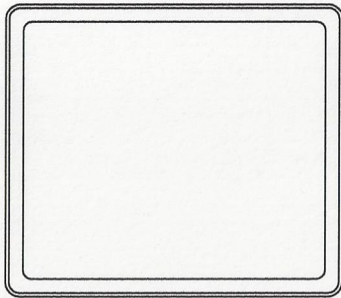

BASE

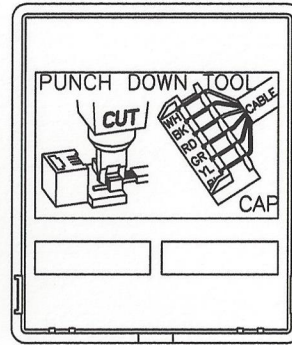

COVER

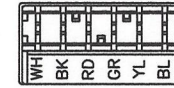

CAP (6P)

ITEM	DESCRIPTION
1	TERMINAL 6P
2	TERMINAL HOLDER 6P
3	BASE
4	COVER
5	CAP 6P

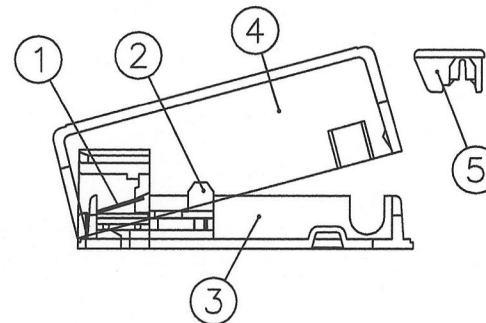
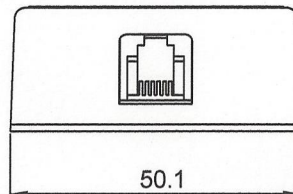
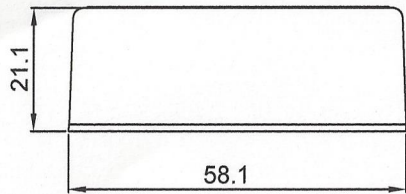

TOLS ~ 20MM ± 0.2MM, OVER 20MM TO 60MM ± 0.4MM, OVER 60MM ± 0.8MM. ANGLES ± 1 DEG

NEXT ASSY:-	DRAWN: E.A. 11/18/2015	CHECKED: EA
TITLE	DWG. NO.	SHEET 1 OF 1
Surface Jack, 6P6C Punchdown Termination	110625-6-XX	REV. A



e-mail...sales@dynacomcorp.com  
 www.dynacomcorp.com